

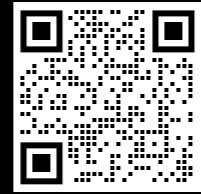

NEW 2024

**lucis.**  
interior lighting

# BOWL



Type: ceiling and wall lamp

Lampshade: white, hand-blown, three-layered glass, satin opal matt

Light body: white painted steel plate

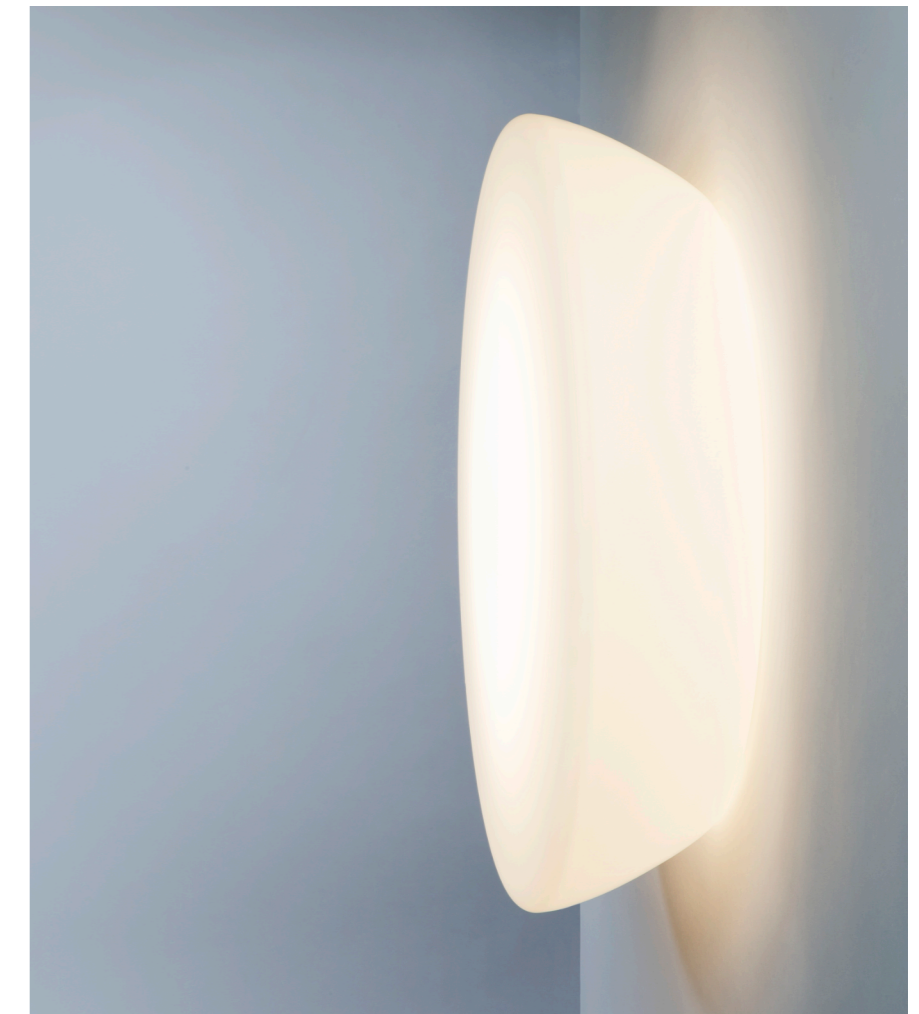
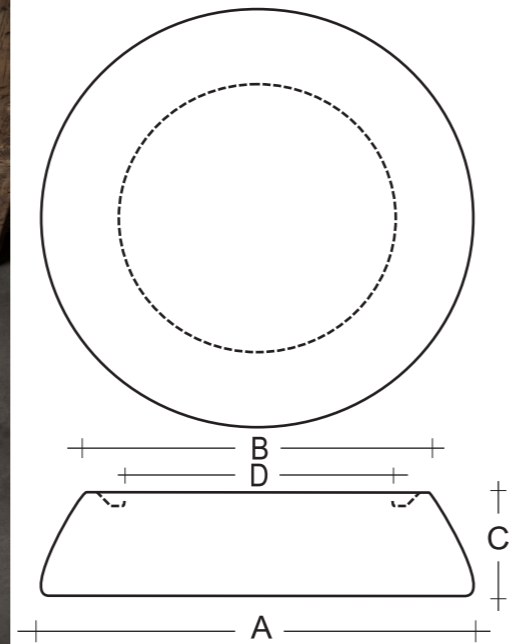

Type	W	K	lm	A	B	C	D	DALI 2	Touch	Dimmer	Bluetooth	Remote	App	Weight
S0.K1.B45.Y	15,5	3000	2450/1856	450	350	110	285	M	-	-	Q*	-	-	4900
S0.K2.B45.Y	15,5	4000	2506/1898	450	350	110	285	M	-	-	Q*	-	-	4900
S0.K3.B45.Y	9,8	3000	1540/1169	450	350	110	285	M	-	-	Q*	-	-	4900
S0.K4.B45.Y	9,8	4000	1575/1196	450	350	110	285	M	-	-	Q*	-	-	4900
S0.K1.B50.Y	30,3	3000	4897/3714	505	407	110	332	M	O*	P*	Q*	-	-	7300
S0.K2.B50.Y	30,3	4000	5009/3799	505	407	110	332	M	O*	P*	Q*	-	-	7300
S0.K3.B50.Y	19,7	3000	3198/2426	505	407	110	332	M	O*	P*	Q*	-	-	7300
S0.K4.B50.Y	19,7	4000	3271/2481	505	407	110	332	M	O*	P*	Q*	-	-	7300

Y -  M  O  P  Q (code without Y = standard version, Y\* = functions available on inquiry)

# OMNIA GLASS

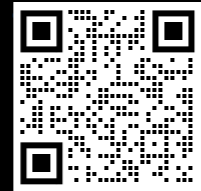

Type: suspension lamp

Lampshade: hand-blown crystal glass with LED source /direct, indirect/ placed in metal housing and protected by opal diffusers

Metal parts: painted steel plate RAL Copper (.72), RAL Bronze (.73), RAL Brass (.74), RAL Gold (.71)

Pendant: wire suspension with black cable

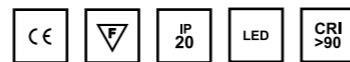
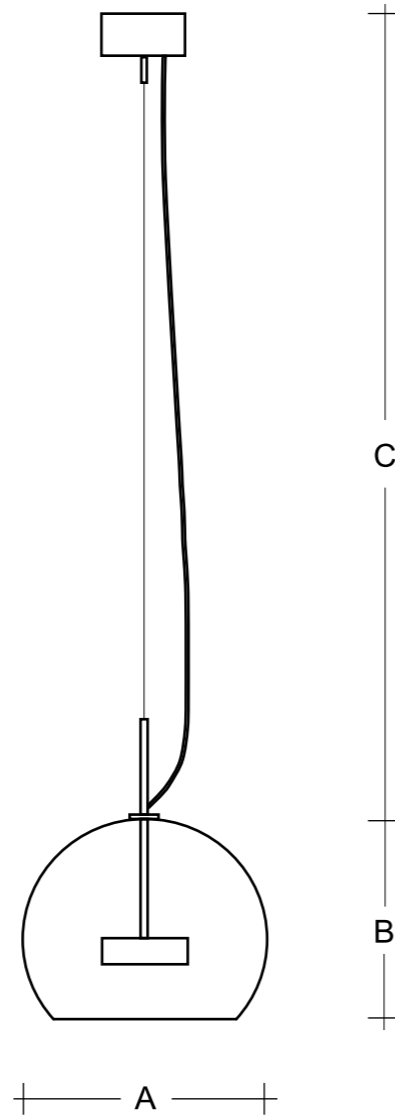

Type	W	K	Im	A	B	C	DALI 2	Touch	Dimmer	Bluetooth	App	Light	Weight
ZL1.K1.N25.XY	9,5	3000	1349/960	250	210	1790	M	-	-	Q*	R*	-	2400
ZL1.K2.N25.XY	9,5	4000	1380/981	250	210	1790	M	-	-	Q*	R*	-	2400
ZL1.K1.N35.XY	9,5	3000	1349/960	350	295	1705	M	-	-	Q*	R*	-	3200
ZL1.K2.N35.XY	9,5	4000	1380/981	350	295	1705	M	-	-	Q*	R*	-	3200

X - 71 ■ 72 ■ 73 ■ 74 ■

Y - M Q R (code without Y = standard version, Y\* = functions available on inquiry)



# NUPAR GLASS



Type: suspension lamp

Lampshade: hand-blown crystal glass with LED source /direct, indirect/ placed in metal housing and protected by opal diffusers

Metal parts: painted steel plate RAL 7016 (.62), RAL Copper (.72), RAL Bronze (.73), RAL Brass (.74), RAL Gold (.71)

Pendant: rod

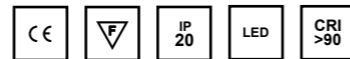
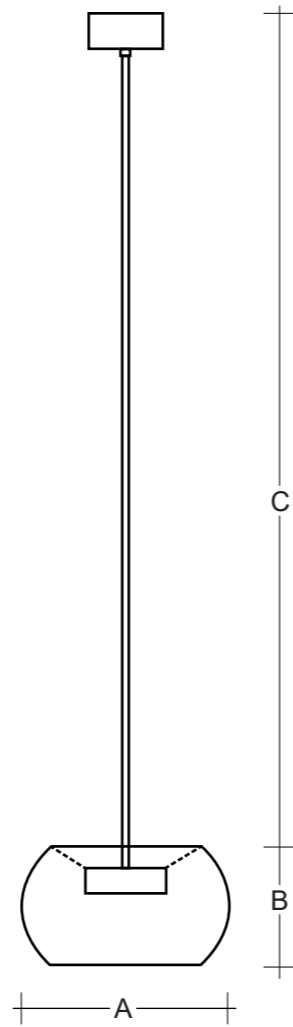

# OMNIA ZT

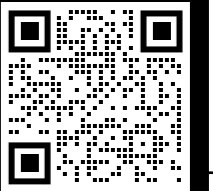

Type: suspension lamp

Lampshade: LED source /direct, indirect/ placed in metal housing and protected by opal diffusers

Metal parts: painted steel plate RAL 7016 (.62), RAL Copper (.72), RAL Bronze (.73), RAL Brass (.74), RAL Gold (.71)

Pendant: rod

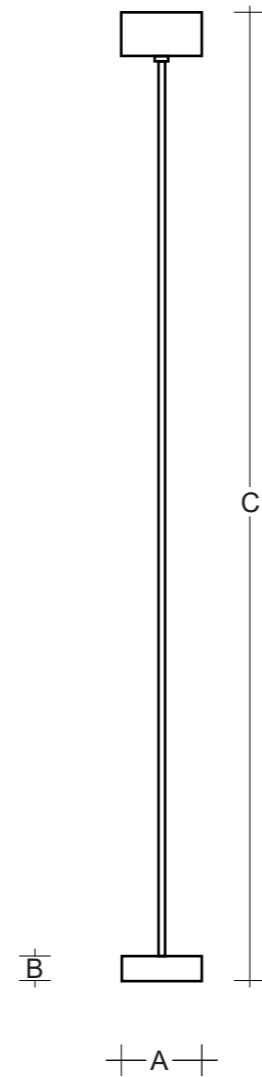

Type	W	K	lm	A	B	C	DALI 2	Touch	Dimmer	Bluetooth	App	IP	Weight
ZT.K1.NU3.XY	9,5	3000	1349/967	350	200	1430	M	-	-	Q*	R*	-	3500
ZT.K2.NU3.XY	9,5	4000	1380/989	350	200	1430	M	-	-	Q*	R*	-	3500

X - 62 ■, 71 ■, 72 ■, 73 ■, 74 ■  
 Y - M Q R (code without Y = standard version, Y\* = functions available on inquiry)

Type	W	K	lm	A	B	C	DALI 2	Touch	Dimmer	Bluetooth	App	IP	Weight
ZT.K1.02.XY	9,5	3000	1349/984	120	37	1500	M	-	-	Q*	R*	-	1500
ZT.K2.02.XY	9,5	4000	1380/1006	120	37	1500	M	-	-	Q*	R*	-	1500

X - 62 ■, 71 ■, 72 ■, 73 ■, 74 ■  
 Y - M Q R (code without Y = standard version, Y\* = functions available on inquiry)

# Pictograms

---



track system - 

---



bluetooth control - 

---



emergency module - 

---



motion sensor - 

---



DALI 2 - 

---



mounting in plasterboard - 

---



the product is in accordance with the European norms

---



for mounting on flammable surface

---



light fittings for fundamental environment

---



Protection against penetration of solid object bigger than 1 mm

---



CRI >90

---



luminaries with LED

---



Tunable White

---



weight in g

(mentioned weights are only route-identification the ground of hand-blown glass – different thickness)

---

LUCIS, s.r.o

Heršpická 814/5a

639 00 Brno

Czech Republic

Tel.: +420 543 248 881

E-mail: [info@lucis.eu](mailto:info@lucis.eu)

[www.lucis.eu](http://www.lucis.eu)

**lucis.**  
interior lighting