

IZAR B MAX ZL4.IB.L1.1500M.91Y

- Type:** suspension lamp
- Lampshade:** acrylic glass
- Metal parts:** white painted steel plate
- Pendant:** steel wire suspension with a transparent cable

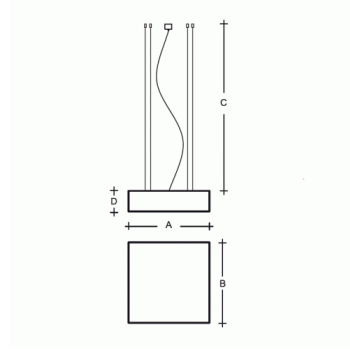

W	K	Module luminous flux lm	Luminaire luminous flux lm	A	B	C	D	DALI 2	Emergency	Bluetooth	Track system	Weight
338	3000	47350	39774	1500	1500	2000	180	M	-	-	Q*	89000

- Voltage:** 230V
- IK code:** IK06
- Ballast:** Driver
- CRI:** >90
- LED life:** L80/F10 50000 hours
- Watt:** 338 W
- Color temperature:** 3000 K
- Module luminous flux:** 47350 lm
- Luminaire luminous flux:** 39774 lm
- A:** 1500 mm
- B:** 1500 mm
- C:** 2000 mm
- D:** 180 mm
- Dali 2:** Available
- Motion sensor:** Not available
- Emergency module:** Not available
- Bluetooth control:** Available on inquiry
- Track system:** Not available
- Sádrokarton:** Not available
- Weight:** 89000 g

Lucis ZL4.IB.L1.1500M.X IZAR B MAX LED / LDC (Polar)

Luminaire: Lucis ZL4.IB.L1.1500M.X IZAR B MAX LED
Lamps: 1 x LED 282989

